

NOTICE
DE
MONTAGE

(GB) INSTRUCTION LEAFLET:
(D) AUFBAUANLEITUNG:

(E) NOTICIA DE MONTAJE:
(P) INSTRUÇÕES DE MONTAGEM:

(I) LIBRETTO DI MONTAGGIO:
(NL) MONTAGEHANDLEIDING:

2296COIF

OUTILLAGES

(GB) TOOLS

(D) HANDWERKZEUGE

(E) HERRAMIENTAS

(P) FERRAMENTAS

(I) ATTREZZATURA

(NL) GEREEDSCHAP

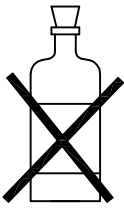
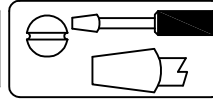
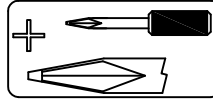
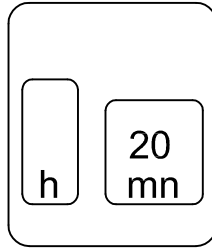
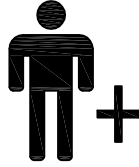

SOLVANT

- (GB) DILUANT
- (D) LOSUNGSMITTEL
- (E) DILUYENTE
- (P) DISSOLVENTE
- (I) SOLVENTE
- (NL) OPLOSMIDDEL

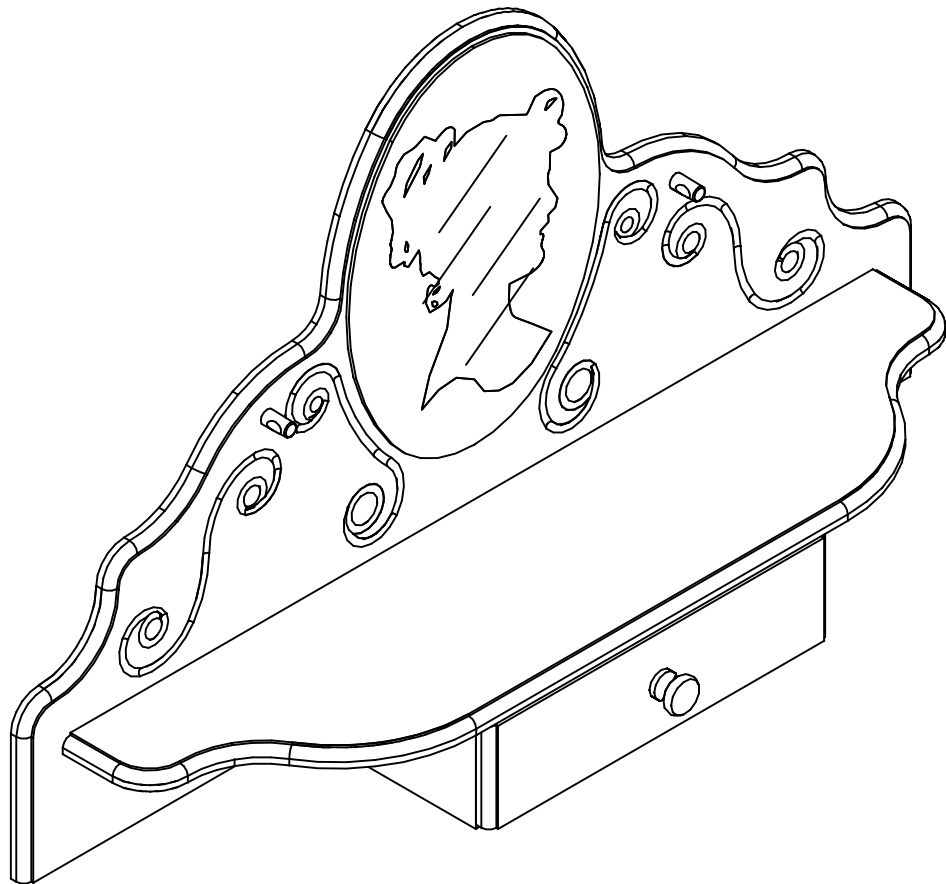

GARDEZ CE DOCUMENT :

POUR L'APRES-VENTE, RETOURNEZ AU MAGASIN AVEC CETTE NOTICE

(GB) PLEASE NOTIFY THE RETAILER WHERE YOU PURCHASED IT FROM, QUOTING:THE REFERENCE OF FURNITURE AND OF THE COMPONENT.

(D) WENDEN SIE SICH BITTE AN IHREN HANDLER UND GEBEN SIE IHM DIE KENNUMMER DES MOBELS UND DIE TEILNUMMER.

(E) CONSERVAR ESTE DOCUMENTO:PARA EL SERVICIO POST VENTA, VUELVA A LA TIENDA CON ESTA NOTICIA.

(P) GUARDAR ESTE DOCUMENTE : PARA DEPOIS DA VENDA, VOLTAR A LOJA COM ESTAS INSTRUÇÕES.

(I) CONSERVARE QUESTO DOCUMENTO:PER OGNI RICHIESTA DOPO ACQUISTO, TORNARE AL NEGOZIO CON QUESTO LIBRETTO.

(NL) BEWAAR DEZE HANDLEIDING GOED. IN GEVAL VAN PROBLEMEN OF EVENTUELE KLACHTEN NEEM DAN DEZE HANDLEIDING, MEE NAAR DE WINKEL WAAR U DE KAST HEEFT GEKOCHT

REPEREZ LES PIECES SUR LA "VUE ECLATEE"

- Ⓒ LOCATE THE PIECES ON THE "CROSS SECTION"
- Ⓓ IDENTIFIZIEREN SIE DIE TEILE AN HAND DER "PERSPEKTIVISCHEN DARSTELLUNG"
- Ⓔ LOCALIZACION DE LAS PIEZAS
- Ⓕ ENCONTRAR AS PECAS NA "VISTA REBINTADA"
- Ⓖ INDIVIDUARE OGNI PEZZO SULLA "VUE ECLATEE"
- Ⓗ PLAATS DE STUKKEN VOLGENS HUN "LOSSE OBSTELLING"

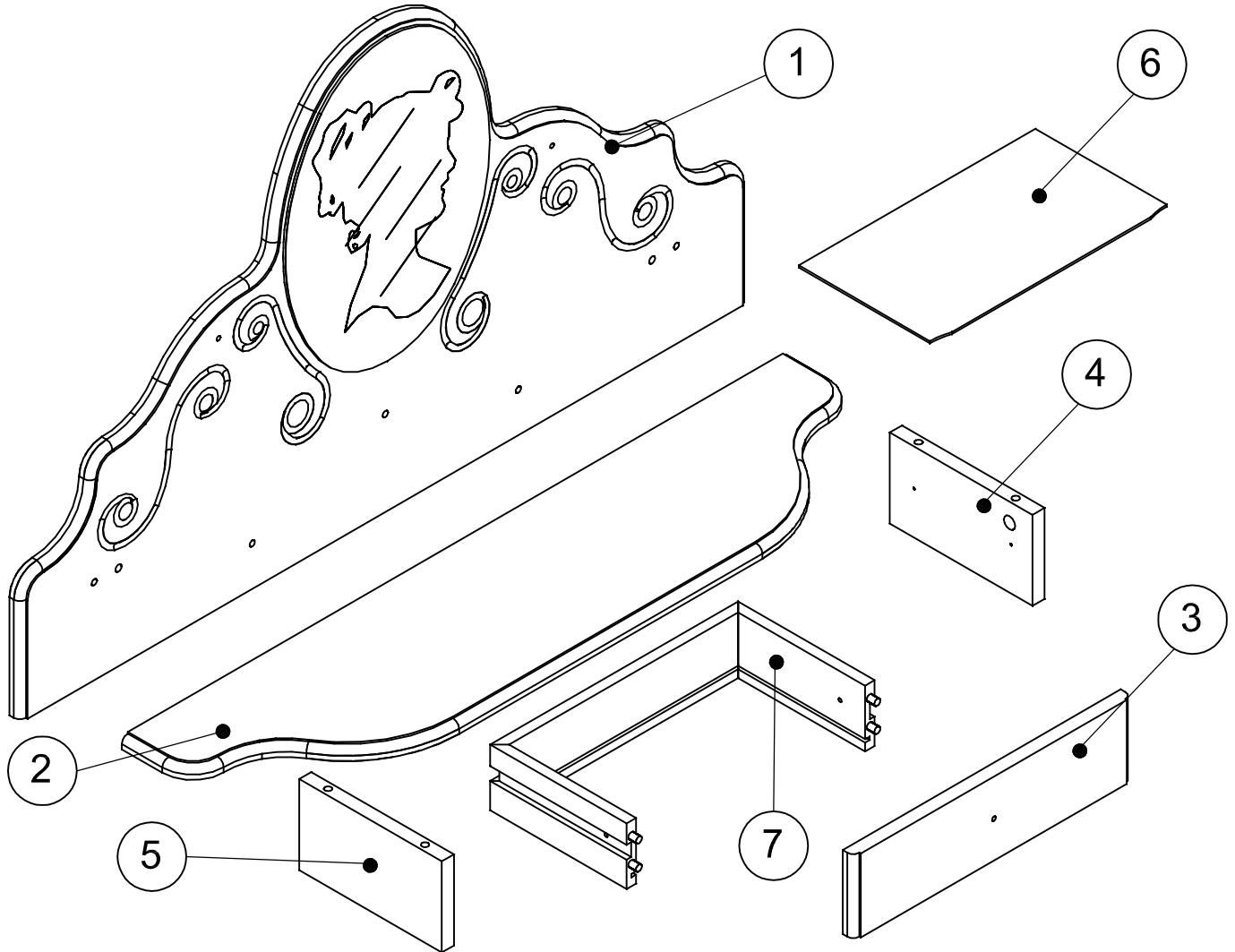

LISTE QUINCAILLERIE

- Ⓒ LIST OF COMPONENTS
- Ⓓ BESCHLAGE
- Ⓔ LISTA DE HERRAJES
- Ⓕ LISTA DE FERRAGENS
- Ⓖ LISTA CHINCAGLIERIA
- Ⓗ LIJST VAN TOEBEHOREN

- REPERE DE LA QUINCAILLERIE
 COMPONENT REFERENCE NUMBER
 TEIL REFERENZ
 CODIFICACION DE LOS HERRAJES
 REFERENCIA DA FERRAGEN
 RIFERIMENTO DELLA CHINCAGLIERIA
 CONTROLE VAN HET TOEBEHOREN

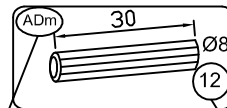

- QUANTITE UTILISEE
 NUMBER OF PIECES
 GEBRAUCHTE MENGE
 CANTIDAD UTILIZADA
 QUANTIDADE UTILISADA
 QUANTITA UTILIZZATA
 GEBRUIKTE HOEVEELHEID

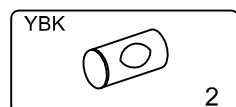
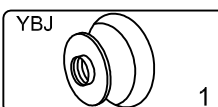
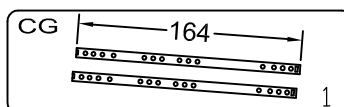
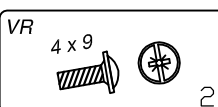
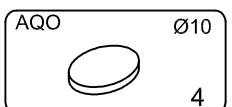
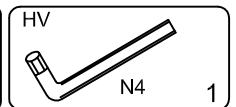
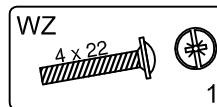
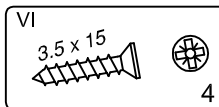
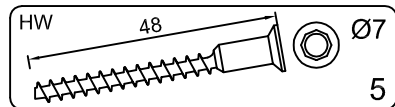
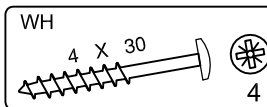
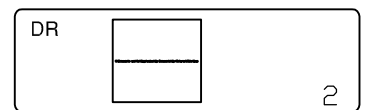
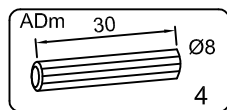
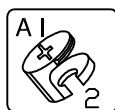
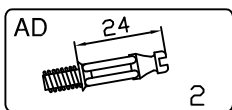

PHASE

1

CF	COLLE
	GLUE
	LEIM
	COLA
	COLLA
	LIJM
	1

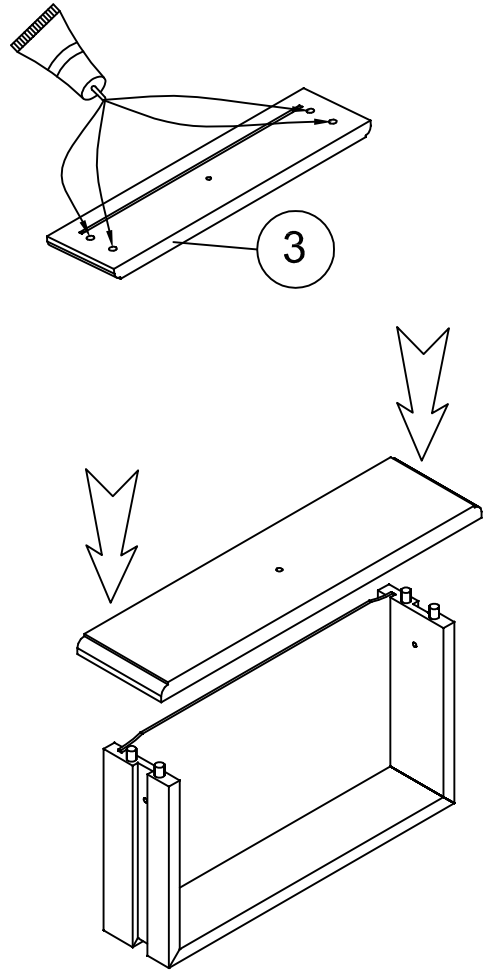
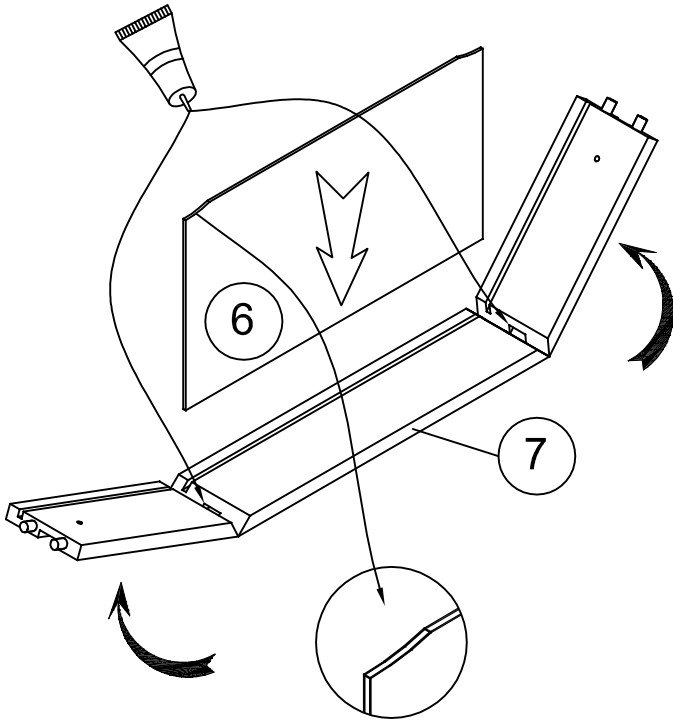

PHASE

2

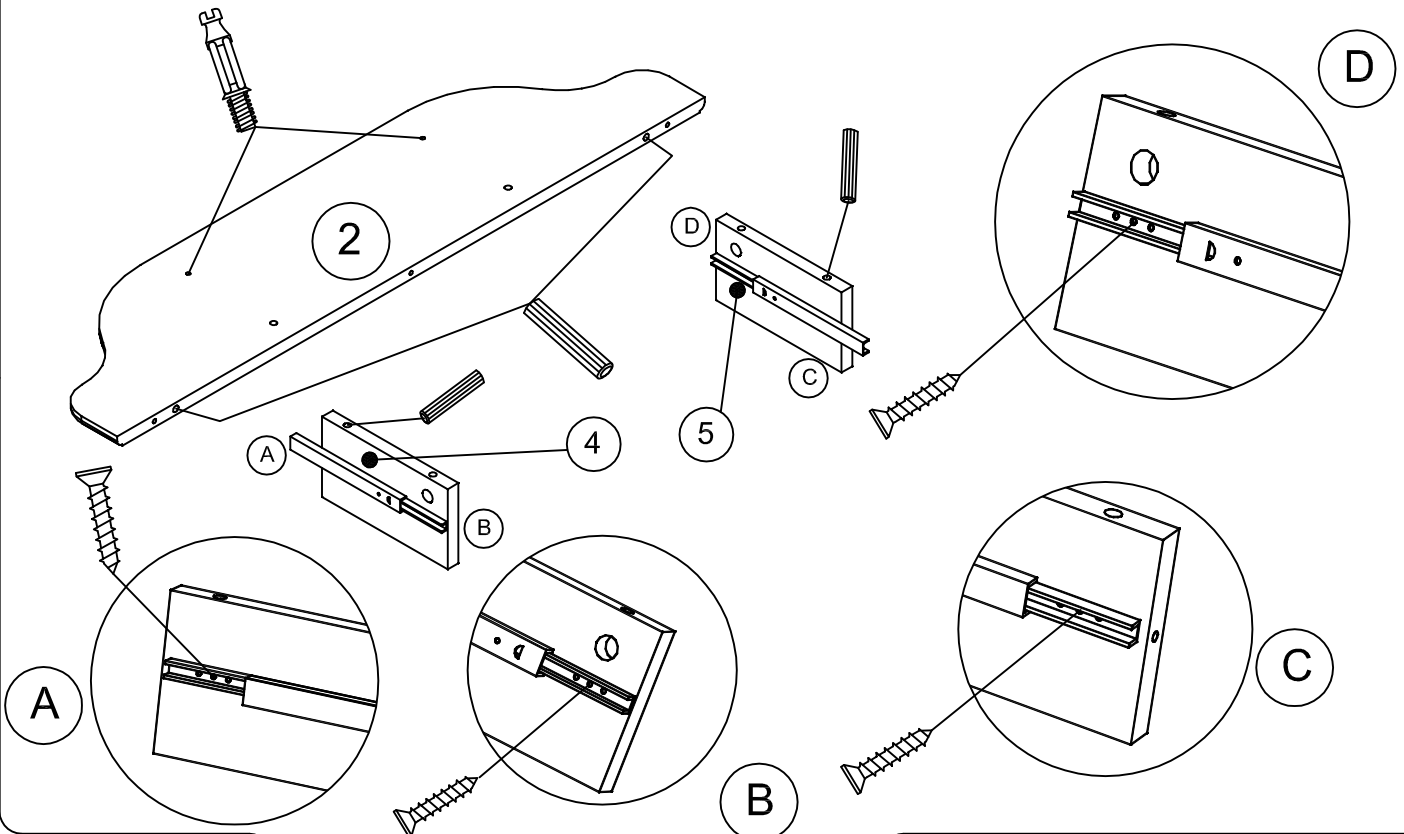
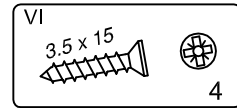
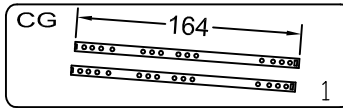
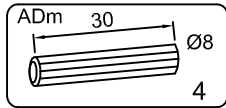
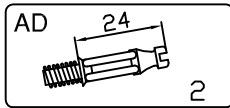

PHASE

3

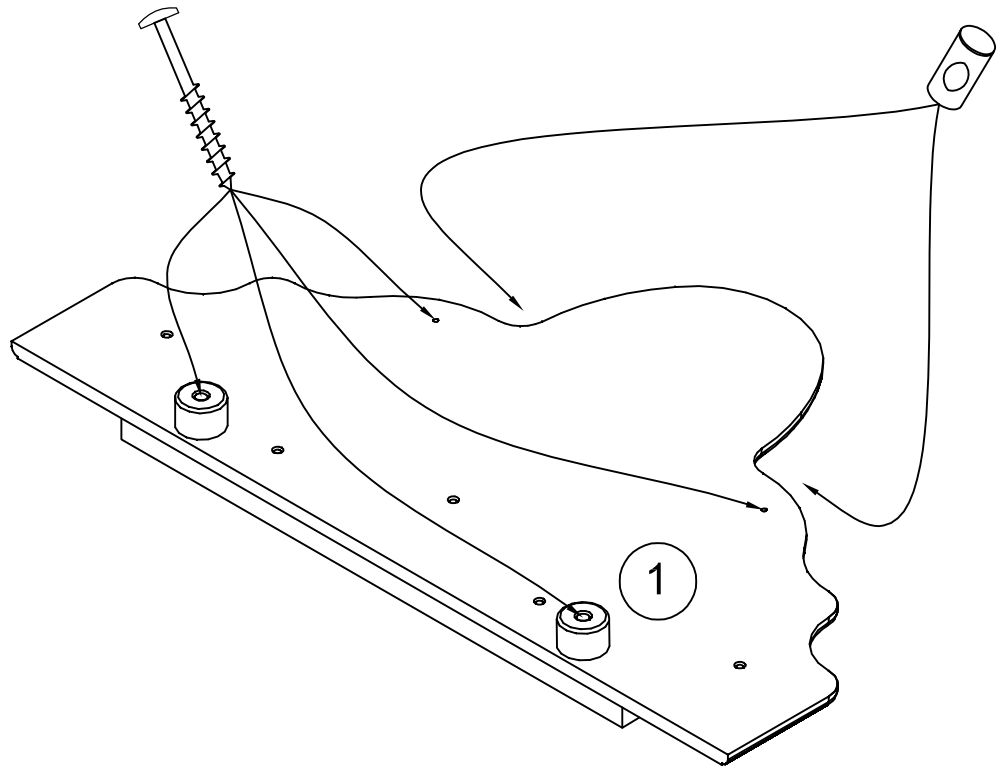
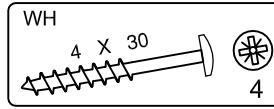
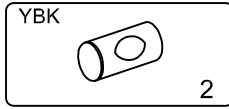

PHASE

4

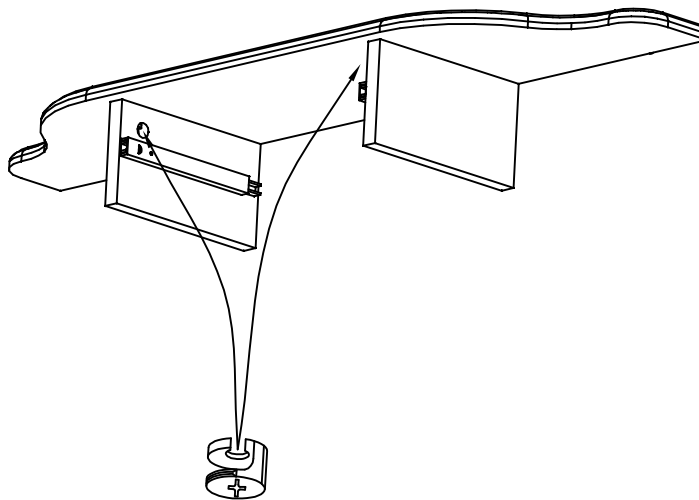

PHASE

5

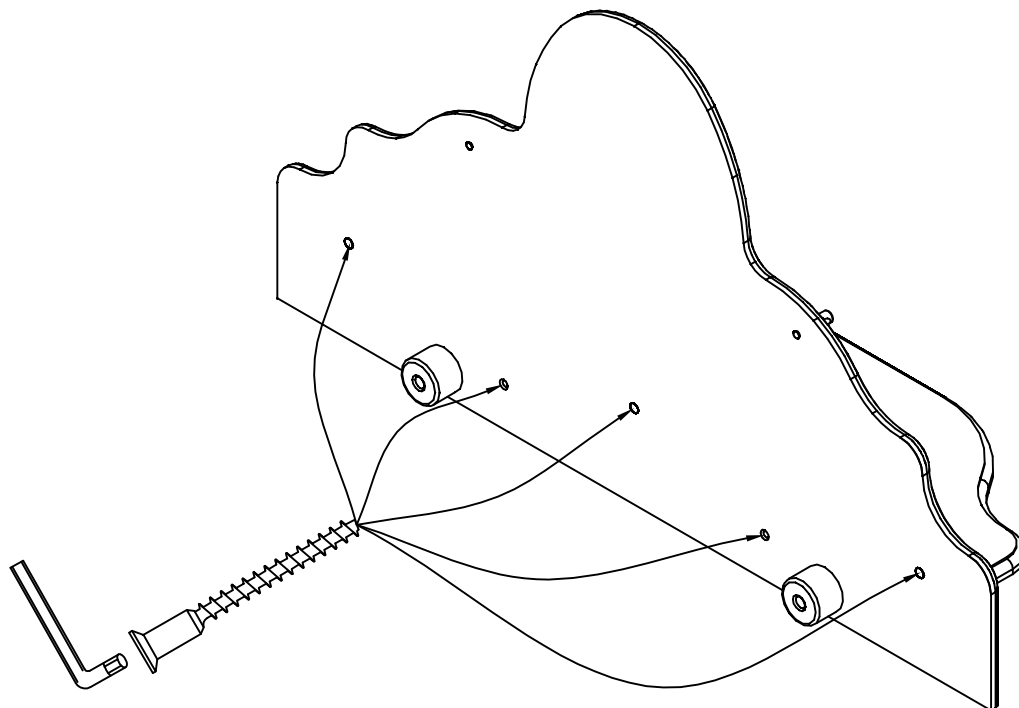
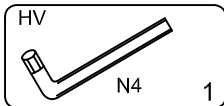
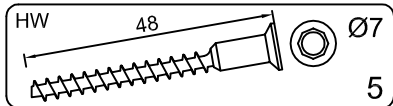

PHASE

6

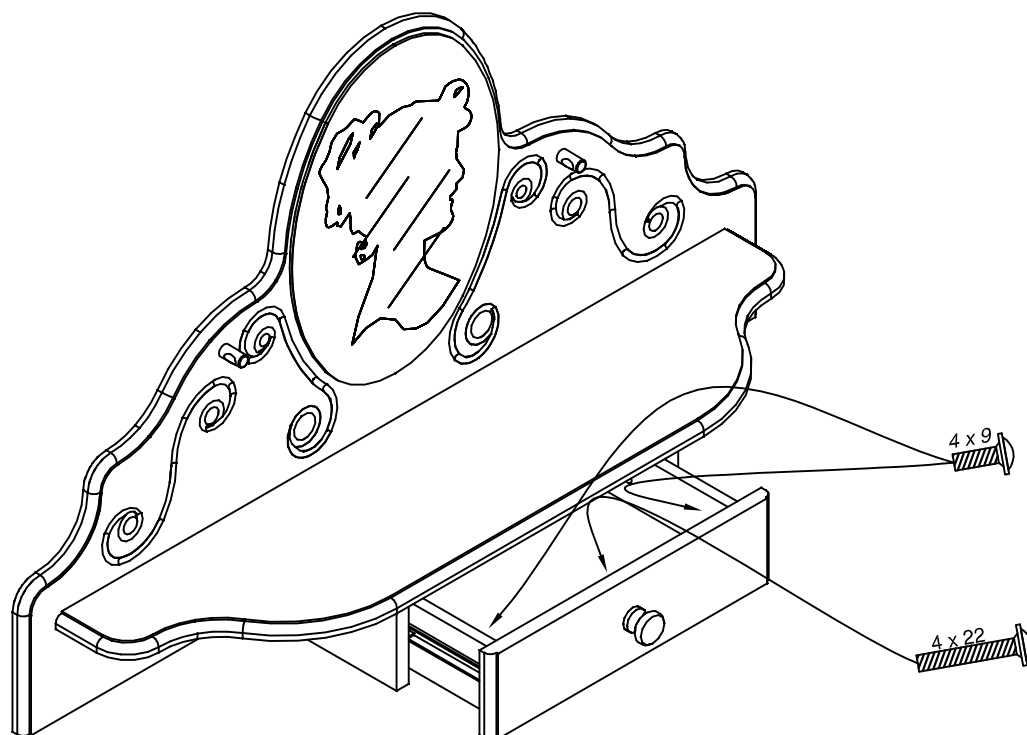
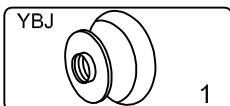
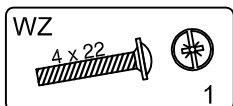
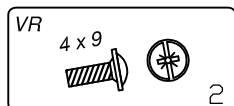

PHASE

7

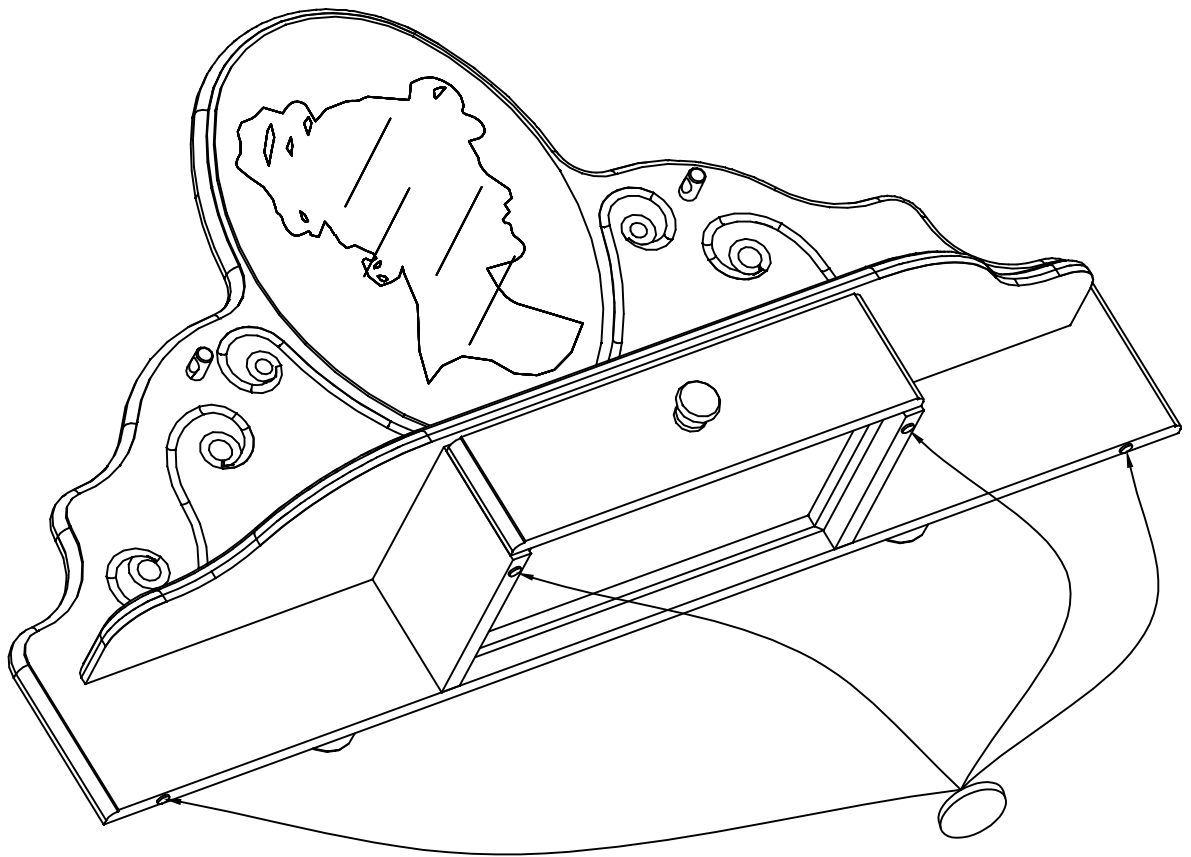
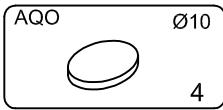

PHASE